

Wireless Current Transducer (50A)

Technical Overview

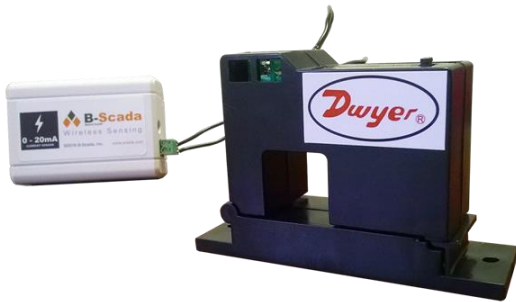

B-Scada™ Wireless Current Transducer Key Features

- Measures the current within a wire up to 50A
- Plug and Sense capability
- Cloud Monitoring using any browser (including on mobile devices)
- LED status indicator
- Supports 915, 868 and 433 MHz frequencies
- Self-hosted option for advanced users
- Uses AC power supply or two (2) AA batteries

General Description

The B-Scada™ Wireless Current Transducer is used to measure the current within a wire. This unit is capable of measuring currents up to 50A.

With B-Scada's cloud monitoring, you can easily view sensor data and set alarms using any web browser (including on mobile devices).

Power Options

This sensor can either use an AC adapter or two (2) AA batteries. When using batteries, it is recommended to use lithium batteries. Alkaline batteries tend to leak which reduces the sensor life.

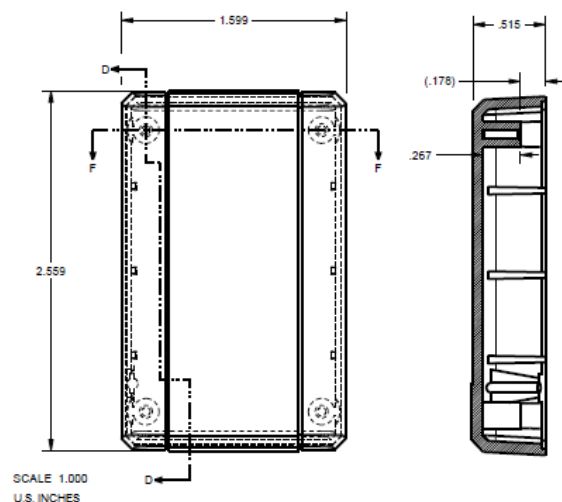

Frequency

The B-Scada™ Wireless Current Transducer supports RF technologies including 915, 868 and 433 MHz sensor solutions.

Applications

- HVAC Units
- Motors
- Any other device powered by alternating current

B-Scada™ Wireless Sensor Core Specifications	
General	
Number of Ports	1 Port: Power
Radio	
Frequency	915 MHz 868 MHz 433 MHz
Antenna	External
Range	Approx. 200m – 400m (625 ft. – 1350 ft.)*
Power	
Power Supply	3.3 V AC Adapter or two (2) AA Batteries**
Visual Indicators	
LED	1 LED: Connection Status***
Mechanical	
Enclosure	Plastic
Dimensions	39.599 x 64.999 x 13.081 mm
Weight	2.20 ounces
Environmental	
Operating Temperature	-7° C to 60° C (20° F to 140° F)

* Actual range may vary depending on environment.

** Battery life will depend on several factors. The update rate or how often the sensor sends data to the gateway affects battery life. Faster update rates utilize more battery. Another factor is the frequency range. The slower the speed (long range), the shorter the battery life due to longer wake and transmit times. Lastly, the type of sensor used. Sensors like the Thermistor uses more power due to extra hardware parts compared to a Water Detection sensor.

*** A blinking LED light indicates a successful connection to the gateway.

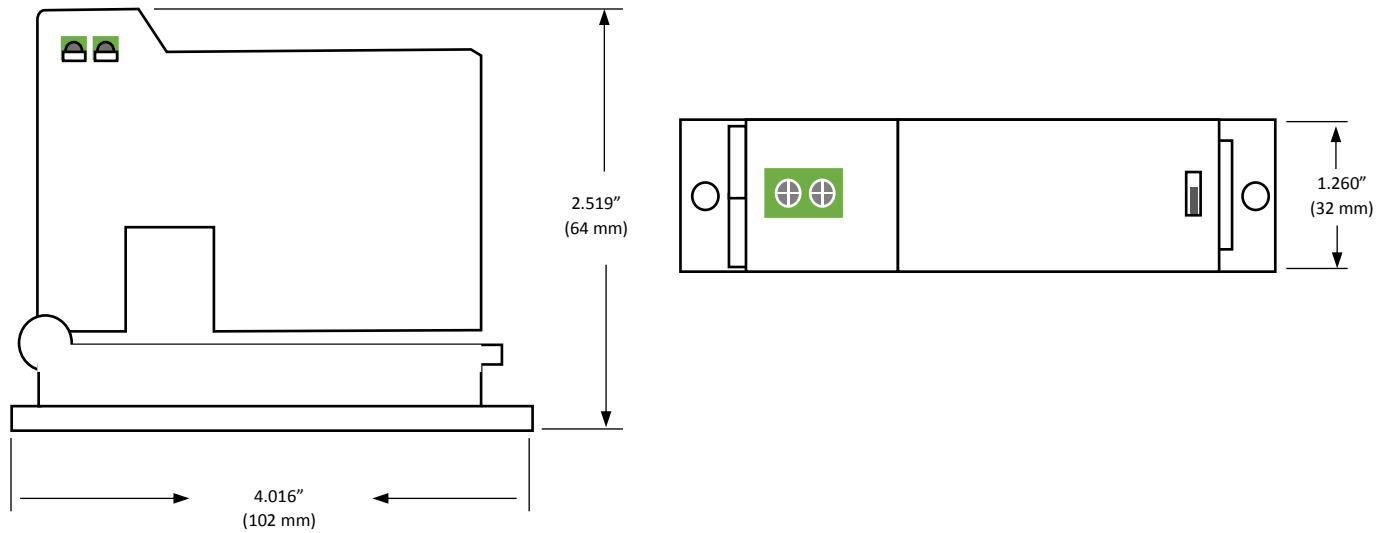

Current Transducer (50A) Specifications	
Sensor Types	Wireless Current Transducer
Current Range	Up to 50A
Power Requirements	Self-Powered
Frequency	10 - 400 Hz
Accuracy	±1%
Operating Temperature	-22° F to 158° F (-30° C to 70° C)
Operating Humidity	0-95% (non-condensing)
Enclosure Rating	UL, V-O Flammability Rated, ABS Plastic Housing
Current Transducer Dimensions	32 x 102 x 64 mm
Weight	4.25 ounces

Notice:

Do not use this product under conditions where there is presence of corrosive gas or deoxidizing gas, flammable gas, dusty conditions, wet or excessively humid locations and other hazardous conditions.

Higher temperature may cause deterioration that will shorten the life of the sensor.



Tel: +1.352.564.9610 Ext. 311
 Cell: +1.352.422.5623
 9030 W Fort Island Trail
 Plantation Village
 Building 9
 Crystal River, FL 34429
<http://www.scada.com>

Complies with FCC and Industry Canada Standards